



ChlorSM Series

SALINE CHLORINATOR

Installation, Operation, and Maintenance Manual



TABLE OF CONTENTS

1.0 DESCRIPTION	3
1.1 General Information	3
1.2 Principals of Operation	3
1.3 General Specifications and Sizing Guidelines	4
2.0 INSTALLATION	8
2.1 Unpacking	8
2.2 Storage	8
2.3 Safety Considerations	8
2.4 Plan Ahead	10
2.5 Additional Parts Required for Installation	10
2.6 Installation Diagram	11
2.7 Power Supply Installation	12
2.8 Electrolytic Cell Installation	12
2.9 Install Kit Installation	13
2.10 Plumbing the System	16
2.11 Plumbing the Power Supply Cooling Lines	16
2.12 System Wiring	17
2.13 Instructions for Adding a Salt Feed Relay	19
2.14 Electrolytic Cell Wiring	19
2.15 Bonding the System	19
3.0 OPERATION	20
3.1 Preparing the Water	20
3.2 Starting the System	20
3.3 System Operation	21
3.4 Display Information	21
4.0 MAINTENANCE	27
4.1 Acid Wash Operation	30
5.0 WARRANTY INFORMATION	34

Note: This manual is subject to change at any time based on system improvements, design changes, authorized modifications or new information. Please consult ChlorKing for the latest revision.

Manufacturer:
ChlorKing Inc
6767 Peachtree Industrial Blvd.
Norcross, GA 30092
1-800-536-8180

SECTION 1 DESCRIPTION

1.1 GENERAL INFORMATION

The ChlorKing® SM Series Saline Chlorination system is the most electrically efficient on-site sodium hypochlorite generator offered by ChlorKing®. The system is designed for commercial swimming pool applications and is capable of producing up to 28 pounds of equivalent chlorine per day. The system manufactures bleach continuously from a salt concentration of 3500 to 5000 ppm added to the pool. The ChlorKing® system is designed for commercial service and can be operated 24 hours a day or controlled by any pool controller. All models have digital displays that show system status, pool salt concentration, and temperature. Models are available in non-reverse and reverse polarity.

1.2 PRINCIPALS OF OPERATION

Electrolytic Cell Assembly

The electrolytic cell assembly consists of a clear PVC cell housing containing an electrolytic cell made from precious metal coated cell plates. Pool water from the pool circulation system is directed through the cell in an off-line installation. The pool water, maintained between 3500 and 5000 ppm salt concentration is converted in the electrolytic cell to sodium hypochlorite. The sodium hypochlorite is then circulated to the pool and combines with organics and further combines to form salt to be used again by the electrolytic cell. This is called a closed loop system because the salt is used repeatedly and is only lost through splash-out, backwashing and rainfall.

Power Supply and Control Box

The power supply provides the current to the electrolytic cells to produce the rated amount of sodium hypochlorite. The power supply uses switched-mode technology, currently the most electrically efficient method of producing current for an electrolytic cell. The power supply houses all the safety features to prevent system operation in the event of a malfunction.

Salt Control

Salt control can be added to the ChlorKing® SM Series Chlorinator. The ChlorKing® SM Series Chlorinator monitors the salt concentration of the pool water and will only allow the system to generate chlorine if the salt concentration is above 3000 ppm to protect the system from low salt. The system uses a non-contacting toroidal sensor to monitor salt concentrations. The toroidal probe is connected to the power supply. The LCD displays the salt concentration. The controller is factory programmed to prevent chlorinator operation in the event of low salt and can be used to automate salt concentrations in the pool with the addition of a Saturated Salt Feeder, peristaltic pump, and relay box.

ChlorKing® Acid Wash

The ChlorKing® Classic SM System (non-reverse polarity) is supplied with a clean in place Acid Wash System. The clean in place Acid Wash System makes cell maintenance quick and easy.

1.3 GENERAL SPECIFICATIONS

SODIUM HYPOCHLORITE PRODUCTION:

Model Designation	Sodium Hypochlorite Production (lbs/day)	Rated Power in DC Amps	Rated Pressure	Minimum Water Flow Rate (gpm)	Inlet Diameter (Inches)	Outlet Diameter (Inches)
Chlor7.5SM	8lbs/day	50	50 psi	20 gpm	1 inch	1 inch
Chlor10.0SM	11lbs/day	50	50 psi	20 gpm	1 inch	1 inch
Chlor12.5SM	14lbs/day	50	50 psi	20 gpm	1 inch	1 inch
Chlor15.0SM	17lbs/day	100	50 psi	20 gpm	1 inch	1 inch
Chlor20.0SM	22lbs/day	100	50 psi	20 gpm	1-1/2 inch	1-1/2 inch
Chlor25.0SM	28lbs/day	100	50 psi	20 gpm	1-1/2 inch	1-1/2 inch
Chlor7.5CSM	8lbs/day	50	50 psi	20 gpm	1 inch	1 inch
Chlor10.0CSM	11lbs/day	50	50 psi	20 gpm	1 inch	1 inch
Chlor15.0CSM	17lbs/day	100	50 psi	20 gpm	1 inch	1 inch
Chlor20.0CSM	22lbs/day	100	50 psi	20 gpm	1 inch	1 inch
Chlor25.0CSM	28lbs/day	100	50 psi	20 gpm	1 inch	1 inch

ELECTRICAL REQUIREMENTS:

Model Designation	AC Input Voltage	Phases	Frequency	Amps	Fuse Size	GFCI Breaker
Chlor7.5SM	110 to 240	1	50/60Hz	15/7.5	20	20
Chlor10.0SM	110 to 240	1	50/60Hz	15/7.5	20	20
Chlor12.5SM	110 to 240	1	50/60Hz	15/7.5	20	20
Chlor15.0SM	208 to 240	1	50/60Hz	15	20	30
Chlor20.0SM	208 to 240	1	50/60Hz	15	20	30
Chlor25.0SM	208 to 240	1	50/60Hz	15	20	30
Chlor7.5CSM	100 to 240	1	50/60Hz	15/7.5	20	20
Chlor10.0CSM	100 to 240	1	50/60Hz	15/7.5	20	20
Chlor15.0CSM	208 to 240	1	50/60Hz	15	20	30
Chlor20.0CSM	208 to 240	1	50/60Hz	15	20	30
Chlor25.0CSM	208 to 240	1	50/60Hz	15	20	30

These systems require a 120 VAC control signal from a chemical feed controller or from a standard 15 amp wall outlet. The control connection is rated at 1 amp.

SPACE REQUIREMENTS:

CHLOR7.5CSM AND CHLOR10.0CSM

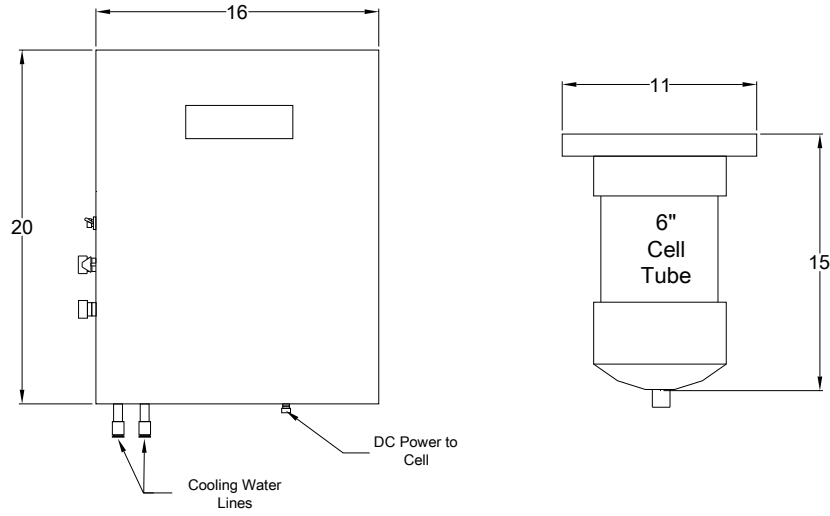

CHLOR7.5SM AND CHLOR10.0SM

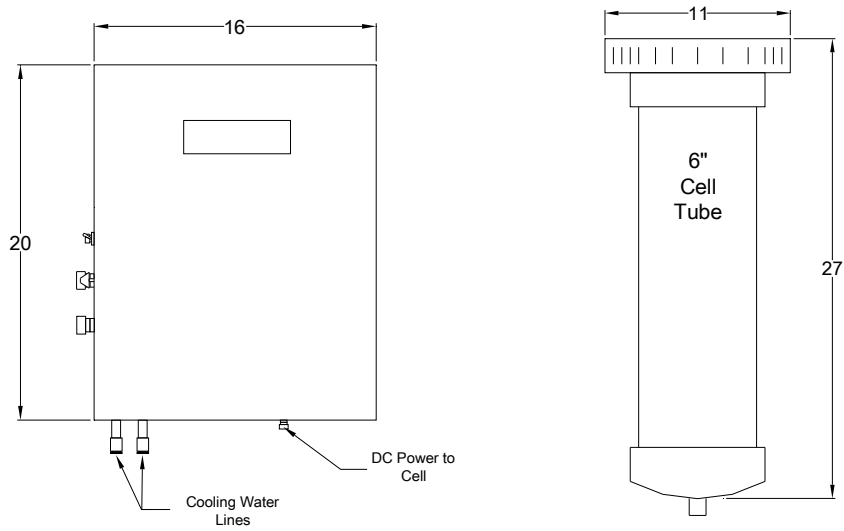

CHLOR15.0SM, CHLOR15.0CSM, CHLOR20.0CSM, AND CHLOR25.0CSM

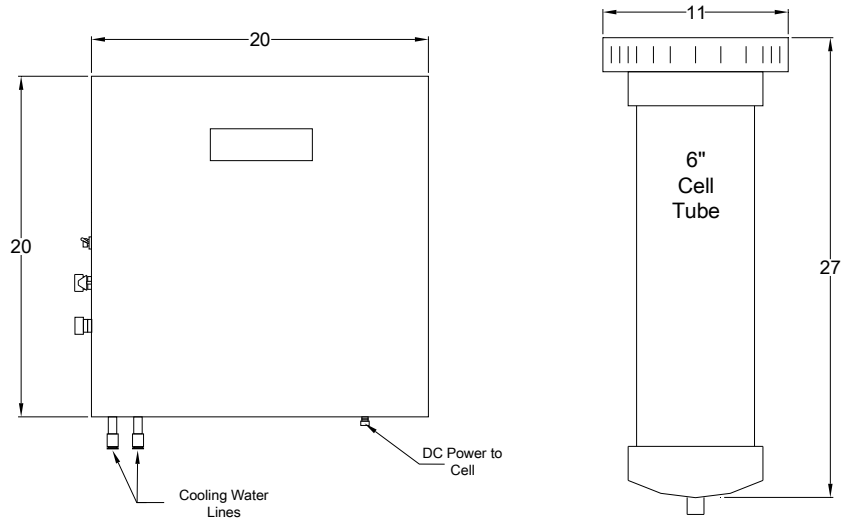

CHLOR20.0SM AND CHLOR25.0SM

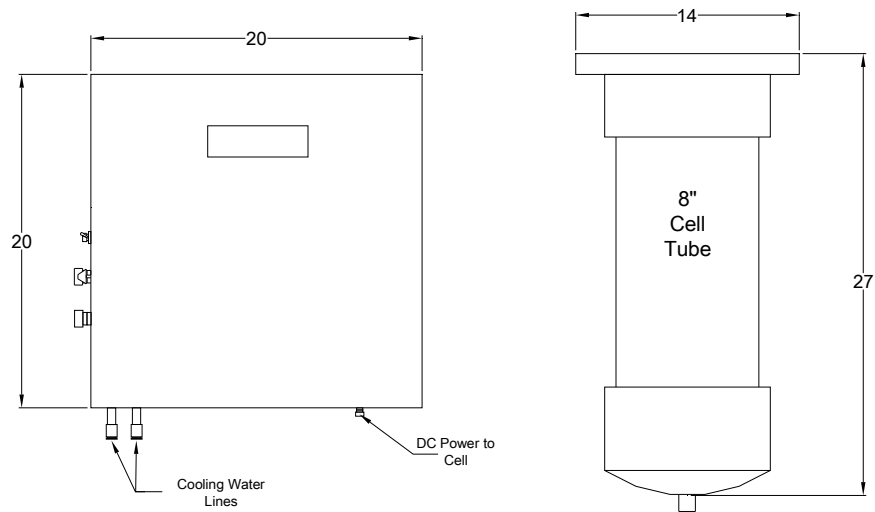

SIZING GUIDELINES

Chlorinator sizing must comply with local codes. Please contact your local health department for specific requirements or contact your local ChlorKing® representative for assistance.

HEAD LOSS DATA

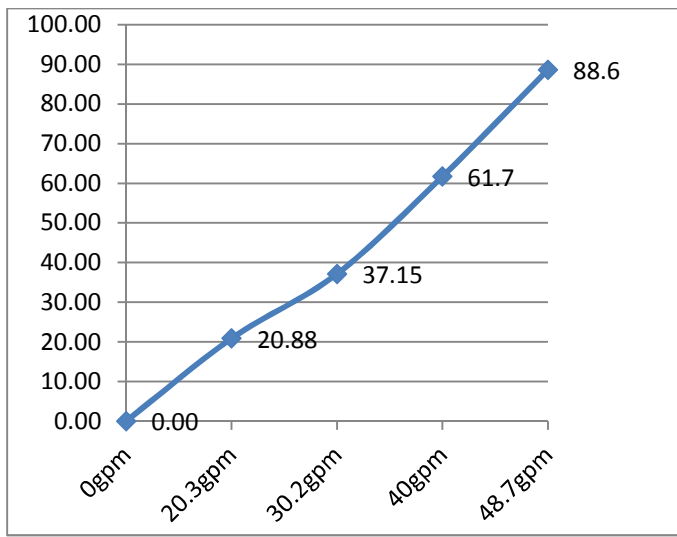

Head Loss Data for Chlor-25.0C.

Head loss data reported in ft H2O as measured by NSF.

Chlor-7.5, Chlor-10.0, Chlor-15.0, Chlor-5.0C, Chlor-7.5C, Chlor-10.0C, Chlor-15.0C, Chlor-20.0C, Chlor-25.0C similar.

SECTION 2 INSTALLATION

2.1 UNPACKING

Units are shipped from the factory. In the event of damages during shipping, it is the responsibility of the customer to notify the carrier immediately and to file a damage claim. Open the crate carefully and examine all material inside. Check against the parts list to be sure that all items are accounted for and intact.

2.2 STORAGE

When storing units, use the original packaging and store under a shelter to protect the contents from weather.

2.3 SAFETY CONSIDERATIONS

IMPORTANT SAFETY INSTRUCTIONS READ AND FOLLOW ALL INSTRUCTIONS

SAVE THESE INSTRUCTIONS

WHEN INSTALLING, OPERATING, AND MAINTAINING THIS EQUIPMENT, KEEP SAFETY CONSIDERATIONS FOREMOST. USE PROPER TOOLS, PROTECTIVE CLOTHING, AND EYE PROTECTION WHEN WORKING ON OR INSTALLING THE EQUIPMENT. FOLLOW THE INSTRUCTIONS IN THIS MANUAL AND TAKE ANY ADDITIONAL SAFETY MEASURES APPROPRIATE. BE EXTREMELY CAREFUL IN THE PRESENCE OF HAZARDOUS SUBSTANCES.

THE PERSONNEL RESPONSIBLE FOR INSTALLATION, OPERATION, AND MAINTENANCE OF THIS EQUIPMENT MUST BE FULLY FAMILIAR WITH THE CONTENTS OF THIS MANUAL.

ANY SERVICING OF THIS EQUIPMENT MUST BE DONE WITH THE UNIT FULLY OFF AND DISCONNECTED FROM THE POWER SOURCE AND ALL PRESSURE BLED FROM THE LIQUID LINES.

WARNING

- **CHLORKING® SYSTEMS ARE INTENDED TO BE INSTALLED ACCORDING TO ALL LOCAL AND NATIONAL REGULATIONS.**
- **CONNECT THE EQUIPMENT ASSEMBLY TO A CIRCUIT PROTECTED BY A GROUND-FAULT CIRCUIT-INTERRUPTER.**
- **ONLY A CERTIFIED TECHNICIAN MAY INSTALL AND SERVICE THE CHLORKING® SYSTEM.**

- MODIFYING THE **CHLORKING®** SYSTEM IN ANY WAY MAY CAUSE BODILY INJURY AND WILL VOID THE WARRANTY.
- DO NOT ALLOW CHILDREN TO OPERATE THE **CHLORKING®** SYSTEM.
- ONLY REPLACE COMPONENTS WITH THOSE SPECIFIED BY THE MANUFACTURER.
- WHEN INSTALLING THE SYSTEM, ENSURE THAT POWER IS LINKED TO THE MAIN PUMP POWER SOURCE FOR THE POOL TO ENSURE THAT THE **CHLORKING®** SYSTEM NEVER OPERATES WHEN THE PUMPS ARE OFF.
- ALL BOXES ON THE **CHLORKING®** SYSTEM CONTAIN HIGH VOLTAGE COMPONENTS. NEVER OPEN ANY BOX WHILE THE POWER IS ON.
- THE SYSTEM HAS THE POTENTIAL TO RELEASE HIGH DOSES OF CHORINE. USE CAUTION WHEN HANDLING, SERVICING, OR OPERATING THE EQUIPMENT.
- DO NOT ENERGIZE OR OPERATE THE SYSTEM IF THE CELL HOUSING IS DAMAGED OR IMPROPERLY ASSEMBLED.
- CORD CONNECTED AT TIME OF MANUFACTURE
 - DANGER – Risk of injury
 - Replace damaged cord immediately
 - Do not bury cord

CONSIGNES DE SÉCURITÉ IMPORTANTES LISEZ ET SUIVEZ TOUTES LES INSTRUCTIONS

CONSERVEZ CES INSTRUCTIONS

LORS DE L'INSTALLATION, DE FONCTIONNEMENT ET L'ENTRETIEN DE CET ÉQUIPEMENT, GARDEZ LES CONSIDÉRATIONS SUR LA SÉCURITÉ AVANT TOUT. UTILISER DES OUTILS APPROPRIÉS, DES VÊTEMENTS DE PROTECTION ET LUNETTES DE PROTECTION LORSQU'ILS TRAVAILLENT SUR OU À L'INSTALLATION. SUIVEZ LES INSTRUCTIONS DE CE MANUEL ET PREND LES MESURES DE SÉCURITÉ SUPPLÉMENTAIRES APPROPRIÉES. SOYEZ VIGILANTS EN PRÉSENCE DE SUBSTANCES DANGEREUSES.

LE PERSONNEL CHARGÉ DE L'INSTALLATION, DE FONCTIONNEMENT ET D'ENTRETIEN DE CE MATÉRIEL DOIT ÊTRE PARFAITEMENT FAMILIARISÉ AVEC LE CONTENU DE CE MANUEL.

AUCUNE OPÉRATION DE MAINTENANCE DE CET ÉQUIPEMENT DOIT ÊTRE FAITE AVEC L'UNITÉ ENTIÈREMENT ÉTEINT ET DÉBRANCHÉE DE L'ÉLECTRICITÉ ET TOUTE LA PRESSON SAIGNÉ À PARTIR DES LIGNES DE LIQUIDES.

MISE EN GARDE

- **CHLORKING®** SYSTEMES SONT DESTINES A ETRE INSTALLEES SELON TOUS LES REGLEMENTS LOCAUX ET NATIONAUX.

- CONNECTER LE MONTAGE DE L'ÉQUIPEMENT SUR UN CIRCUIT PROTÉGÉ PAR UN DISJONCTEUR DE FUITE À LA TERRE.
- SEUL UN TECHNICIEN CERTIFIÉ PEUT INSTALLER ET ENTREtenir LE **CHLORKING®** SYSTEM.
- MODIFIANT LA **CHLORKING®** SYSTEM EN QUELQUE SORTE PEUT CAUSER DES LESIONS CORPORELLES ET LA GARANTIE ANNULATION.
- NE LAISSEZ PAS LES ENFANTS A EXPLOITER LE **CHLORKING®** SYSTEM.
- REMPLACEZ UNIQUEMENT LES COMPOSANTS AVEC CELLES SPÉCIFIÉES PAR LE FABRICANT.
- LORSQUE VOUS INSTALLEZ LE SYSTEME, S'ASSURER QUE LA PUISSANCE EST LIEE A LA SOURCE D'ALIMENTATION DE POMPE A MAIN POUR LA PISCINE POUR VOUS ASSURER QUE LE SYSTEME **CHLORKING®** FONCTIONNE JAMAIS QUAND LES POMPES SONT HORS SERVICE.
- TOUTES LES CASES SUR LE **CHLORKING®** SYSTEME CONTIENNENT DES COMPOSANTS HAUTE TENSION. NE JAMAIS OUVRIR N'IMPORTE QUELLE BOÎTE TANDIS QUE L'APPAREIL EST ALLUMÉ.
- LE SYSTÈME A LA POSSIBILITÉ DE LIBÉRER DES DOSES ÉLEVÉES DE CHLORE. SOYEZ PRUDENT LORS DE MANIPULATION, ENTRETIEN OU FONCTIONNEMENT DE L'ÉQUIPEMENT.
- NE PAS METTRE SOUS TENSION OU FAIRE FONCTIONNER LE SYSTÈME SI LE BOÎTIER DE LA CELLULE EST ENDOMMAGÉ OU MAL ASSEMBLÉ.
- CORDON CONNECTE AU MOMENT DE LA FABRICATION
 - DANGER-RISQUE DE BLESSURE
 - REMPLACEZ IMMEDIATEMENT LE CORDON D'ALIMENTATION
 - NE PAS ENFOUR LE CORDON

2.4 PLAN AHEAD

Almost every pump room encountered is different. It is imperative to have prior knowledge of the facility in which the unit is to be installed and to evaluate what type of tools, wall anchors, etc. will be needed to make the installation as problem free as possible.

2.5 ADDITIONAL PARTS REQUIRED FOR INSTALLATION

Polypropylene tubing, both ½ and 3/8 inch
 1 or 1-1/2 inch PVC tubing or pipe
 PVC fittings as needed
 Anchors and mounting hardware

2.6 INSTALLATION DIAGRAM

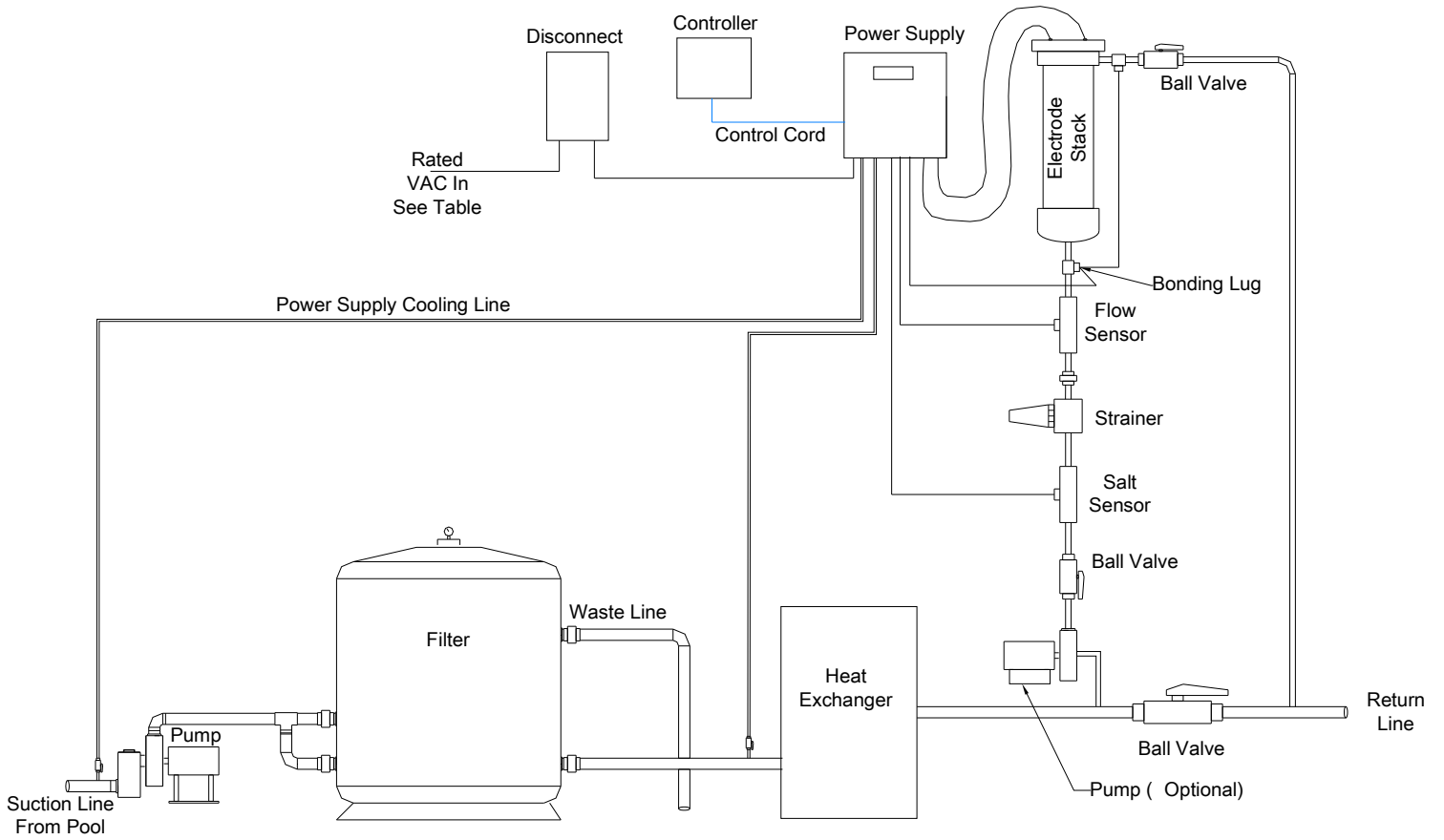

2.7 POWER SUPPLY INSTALLATION

WARNING

THE MOUNTING LOCATION OF THE UNIT MUST BE AT LEAST 1.5 METERS FROM THE POOL.

NEVER TRY TO SUPPORT THE WEIGHT OF THE POWER SUPPLY OR ELECTROLYTIC CELL USING ONLY DRYWALL ANCHORS.

Locate a space on the wall, in the equipment room, that will accommodate the dimensions of the system. Mount the power supply to the wall using appropriate hardware. The power supply must be installed no more than 8 feet from the cell housing to ensure that the cables will reach the cell.

2.8 ELECTROLYTIC CELL INSTALLATION

WARNING

THE MOUNTING LOCATION OF THE ELECTROLYTIC CELL MUST BE AT LEAST 1.5 METERS FROM THE POOL.

Install the cell mounting bracket to the wall using appropriate hardware. Ensure that the wall mount is level. Mount the electrolytic cell and tube to the mounting backboard. Ensure that the cell and tube are mounted within 8 feet of the power supply and that nothing is installed above the cell tube. The cell may need to be removed for service.

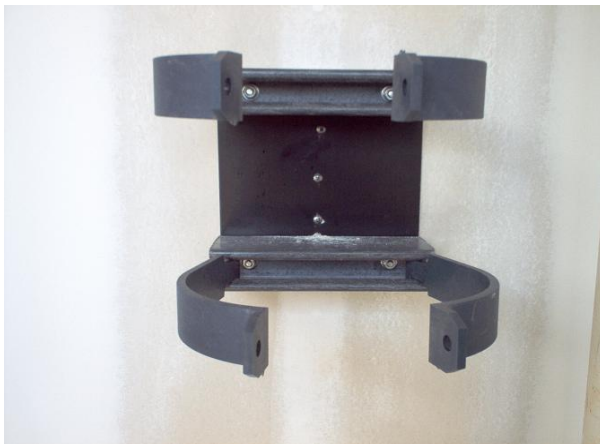

2.9 INSTALL KIT INSTALLATION

Install the parts found in the installation kit in the order shown in the following diagram. **NOTE:** The flow switch must be installed with the arrow facing the bottom of the cell tube.

Chlor7.5SM, Chlor10.0SM, Chlor15.0SM Assembly Diagram

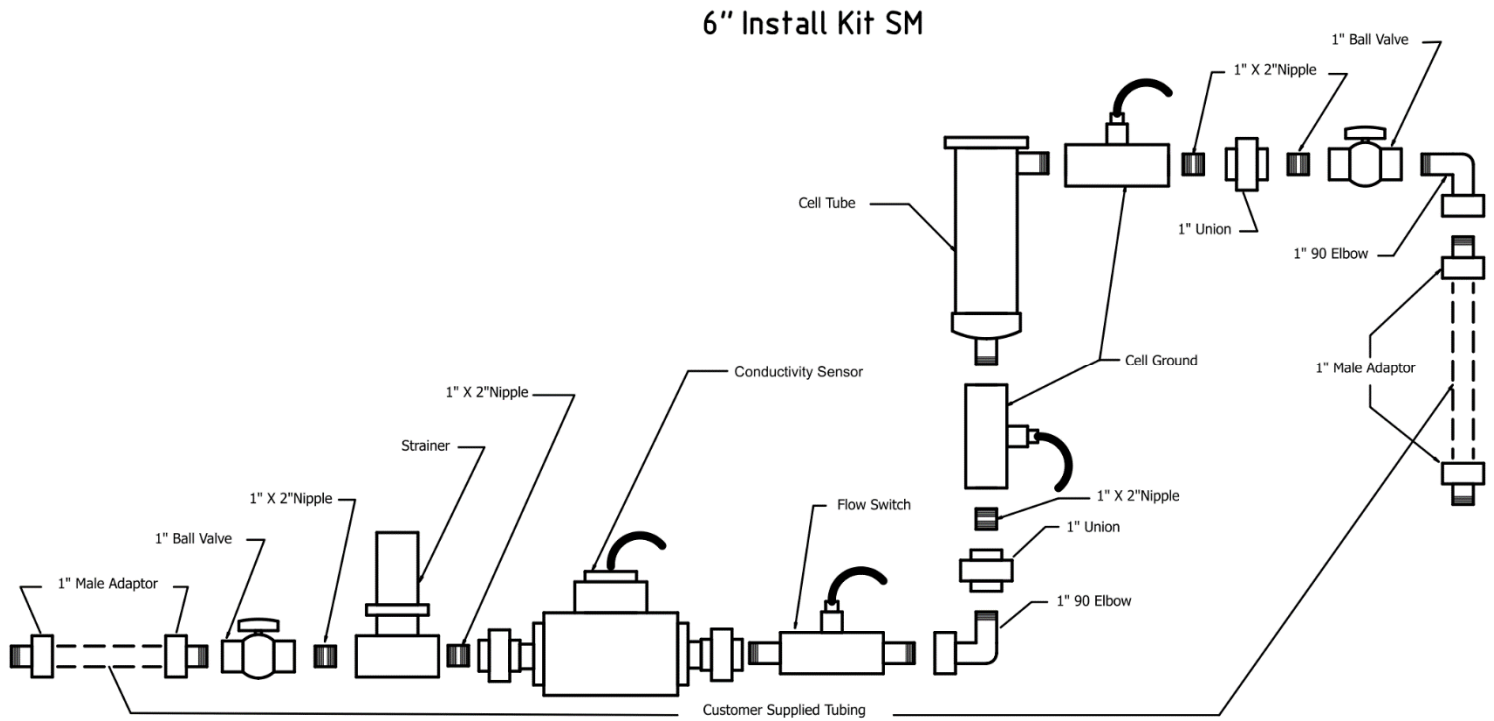

Chlor20.0SM, Chlor25.0SM Assembly Diagram

8" Install Kit SM

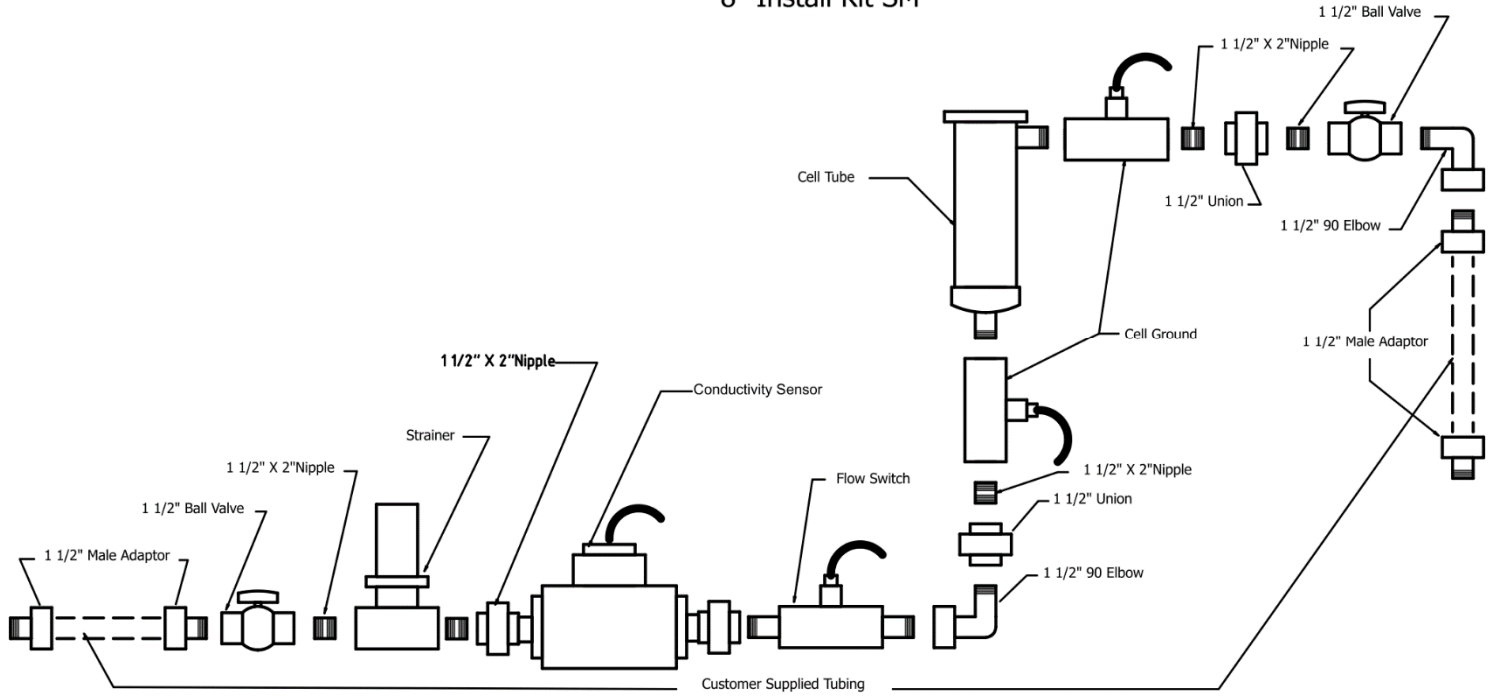

Chor7.5CSM, Chlor10.0CSM, Chlor15.0CSM, Chlor20.0CSM, Chlor25.0CSM Assembly Diagram

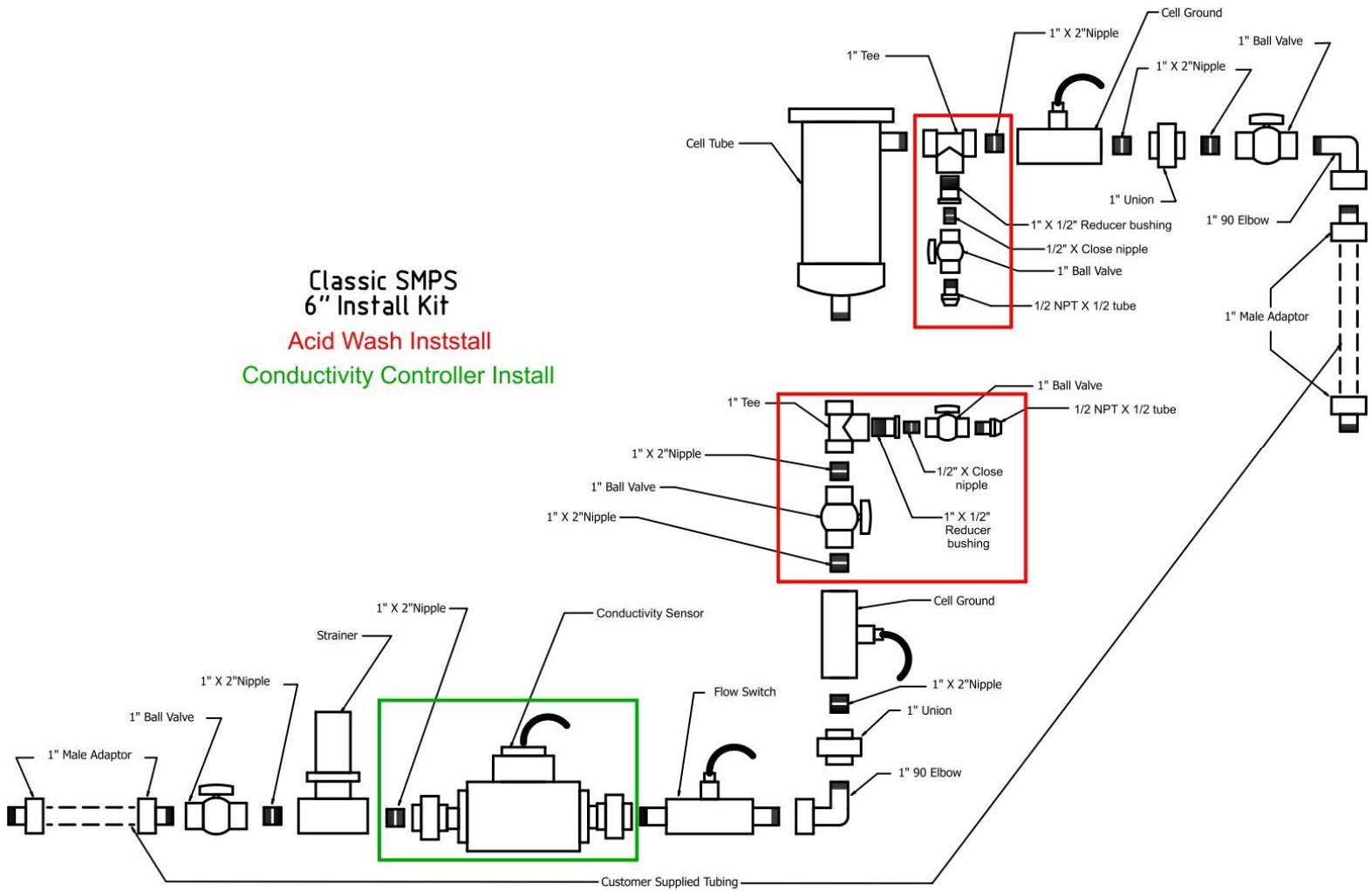

Classic SMPS
6" Install Kit

Acid Wash Install

Conductivity Controller Install

2.10 PLUMBING THE SYSTEM

Chlorking® systems require a minimum of 20 gpm of flow through the electrolytic cell to achieve the rated production of chlorine. The cell housing is plumbed using a bypass to achieve the 20 gpm of flow required. The cell housing must be installed as the last component in the return line of the pool, after all other equipment. See the plumbing diagram below.

2.11 PLUMBING THE POWER SUPPLY COOLING LINES

The power supply cooling lines are plumbed from the return line to pump suction. The cooler lines on the power supply will accommodate 3/8 inch tubing.

NOTE: If a chemical feed controller is being used, the same 3/8 inch tubing can be used for both the sample cell and power supply cooling. Plumb the tubing from the return line into the controller sample cell, then from the sample cell to the power supply cooler, and from the cooler to pump suction.

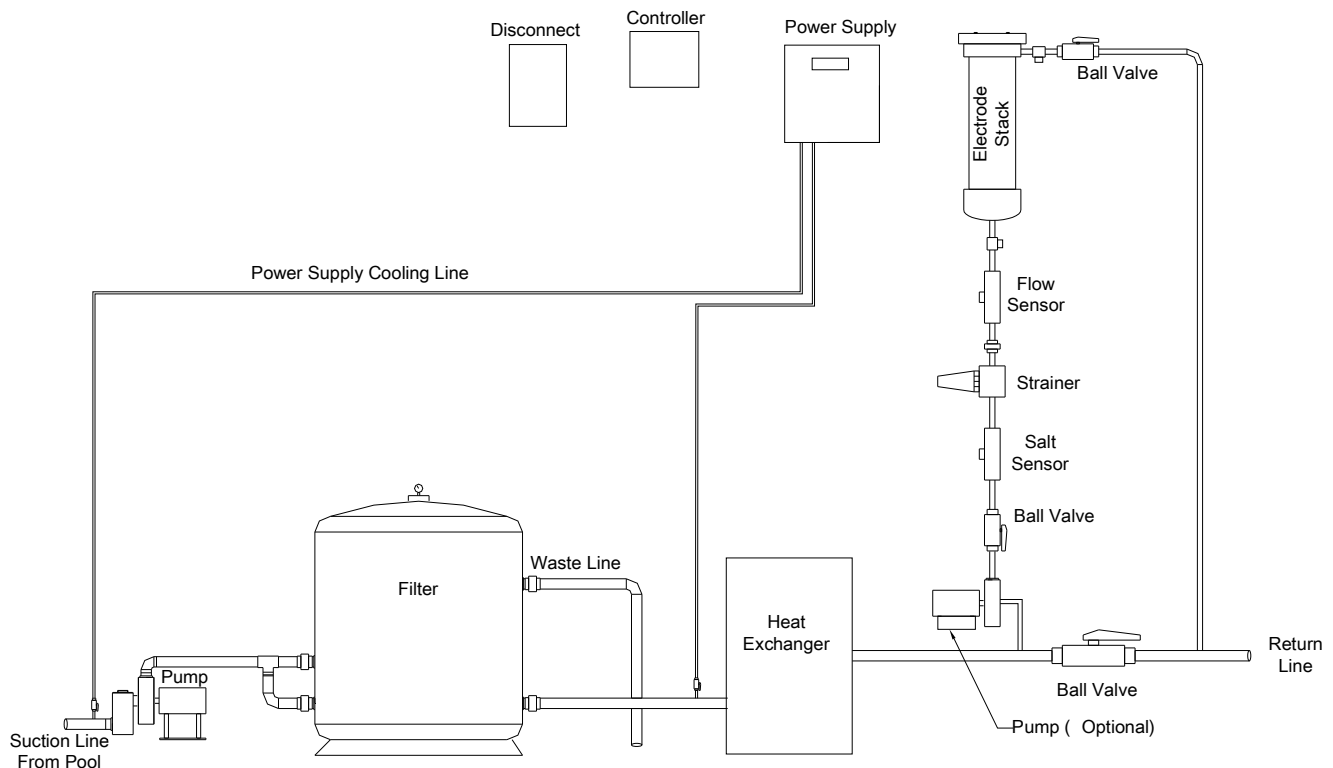

2.12 SYSTEM WIRING

WARNING

THE EARTH TERMINALS AND THE EQUIPMENT BONDING WIRE MUST BE CONNECTED. THE ELECTRICAL SUPPLY MUST MATCH THE SYSTEM RATED VOLTAGE AND CURRENT. ENSURE THAT POWER IS LINKED TO THE MAIN PUMP POWER SOURCE FOR THE POOL TO ENSURE THAT THE CHLORKING® SYSTEM NEVER OPERATES WHEN THE POOL PUMPS ARE OFF.

For ease of service it is recommended that a manual disconnect box be installed between the electrical service and the system.

Connect the electrical supply from the pool equipment room to the terminal block on the lower left side of the power supply enclosure. Ensure that the electrical service is protected by a ground fault circuit interrupter and is rated for the model that is installed. Chlor7.5 models to Chlor12.5 models can be wired with 110V or 208/240V. Chlor15.0 models to Chlor25.0 models use 208/240V only. See Electrical Requirements on page 4 for details.

7.5 Through 12.5: 110V

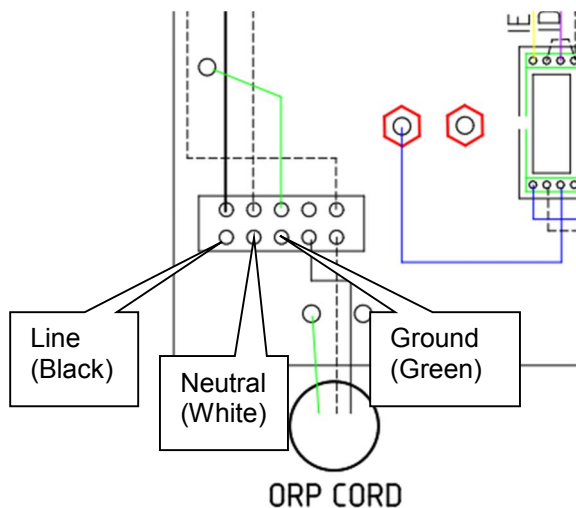

7.5 Through 12.5: 208/240V

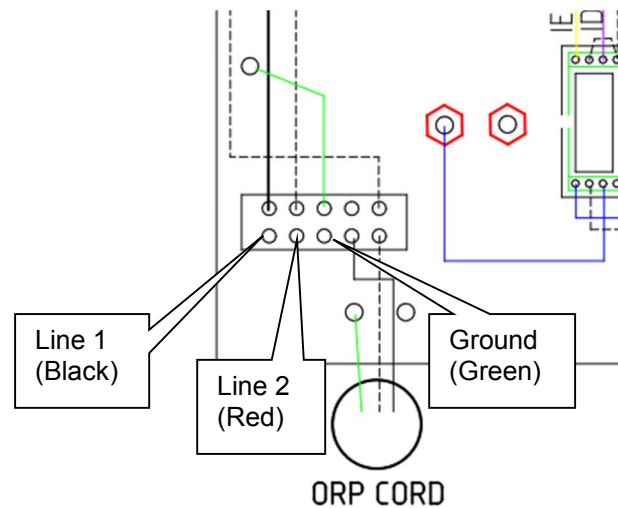

15.0 Through 25.0: 208/240V Only

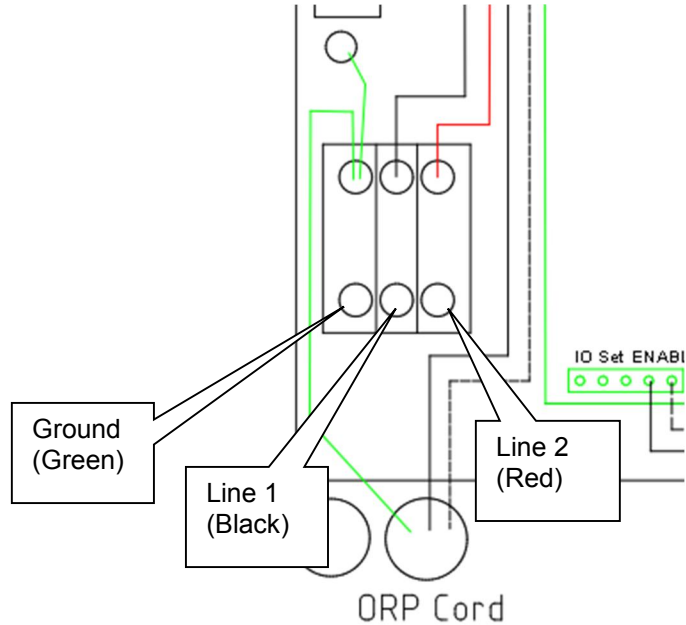

Connect the blue control cord to a chemical feed controller or for manual operation, to a 120 volt AC outlet. When connecting to a chemical feed controller, be sure the controller is set to continuous feed and not set on proportional control. Proportional control will reduce the life of power supply components.

Connect the four pin salt sensor connector to the four pin connector labeled SALT SENSOR.

Connect the two pin flow switch connector to the two pin terminal labeled FLOW SWITCH.

The terminal labeled FEED SALT is used with the optional Saturated Salt Feeder. When using the optional Salt Feeder, plug the cable from the Saturated Salt Feeder Relay Box to the terminal marked FEED SALT.

Connect the red connector from the power supply to the red connector on the cell. **NOTE: Never remove the cables from the top of the cell. Always disconnect the cell with the red connector.**

2.13 INSTRUCTIONS FOR ADDING A SALT FEED RELAY

Mount the salt feed relay box to the wall close enough to the power supply so that the patch cord will connect to the FEED SALT connector on the power supply. Plug the relay box into a 120 VAC outlet. Plug the peristaltic pump used for feeding salt into the output plug on the relay box.

2.14 ELECTROLYTIC CELL WIRING

Connect the red connector from the power supply to the red connector at the cell. **NOTE: Never remove the cables from the top of the cell. Always disconnect the cell with the red connector.**

2.15 BONDING THE SYSTEM

All ChlorKing® systems include cell-bonding assemblies. These assemblies are included in the install kit. The bonding assemblies must be connected with a minimum of 8 AWG bonding wire. Connect the bonding wire from the top cell grounding assembly to the bottom cell grounding assembly and then from the bottom cell grounding assembly to the bonding lug located on the outside of the power supply. The bonding lugs on the power supply are clearly marked with a decal that reads "Bonding Lugs". Connect the second bonding lug on the power supply to the bonding grid at the facility.

SECTION 3 OPERATION

3.1 PREPARING THE WATER

ChlorKing® saline chlorination systems operate by electrolyzing sodium chloride (salt) that has been added to the pool into sodium hypochlorite (liquid chlorine). In order for the ChlorKing® system to operate salt must be added directly to the pool at least 24 hours before the system is started.

40 pound of salt must be added for every 1,000 gallons of pool water to reach 5000 ppm (i.e.: a 50,000 gallon pool will require 2000 pounds of salt or 50 x 40 pound bags to reach 5000 ppm). Once the salt has been added, brush the surface of the pool continuously until the salt has dissolved. Never leave large amounts of salt on the surface of the pool.

Only use pure NaCl. Do not use salt with additives. Contact your dealer or ChlorKing® for a list of approved salt.

Your pool water should be balanced in the following range before turning your ChlorKing® system on:

Chlorine:	2 – 5 ppm
Total Chlorine:	No more than 0.5 ppm above free chlorine
Ph:	7.2 – 7.6
Alkalinity:	80 – 120
Hardness:	180 – 280 ppm
Salt:	3500 – 5000 ppm
Cyanuric acid:	20 – 50 ppm (Outdoor Pools only)
Phosphates:	Less than 100 ppm

Use standard test kits to check water chemistry, and use either a conductivity tester or salt test strip to check saline levels.

(Note that most conductivity testers require frequent calibration to ensure accurate readings, failure to calibrate the equipment will result in inaccurate readings.)

3.2 STARTING THE SYSTEM

Confirm that the salt concentration is 3500 to 5000 PPM.

Confirm that the valves to and from the cell are in the open position and water is flowing through the cell tube.

Make sure that water is flowing through the water-cooled heat sink.

Ensure that the cord labeled ORP or Controller is plugged either into a controller or directly into a wall outlet.

Be sure the disconnect box is in the on position.

Confirm that the output control knob located on the left side of the power supply is turned fully clockwise.

Depending on the model, the system will begin producing chlorine in 10 to 60 seconds.

If the ChlorKing® system is linked to a chemical feed controller, adjust the output to the system maximum, which will allow for full production every time the controller calls for it. If the system is being operated manually, adjust the system to find the point at which chlorine levels are maintained to the desired level. This may take several days of monitoring.

ChlorKing® systems connected to a chemical feed controller will only operate when the controller is in feed mode. Make sure that the chemical feed controller is not set in proportional mode or system damage may occur.

3.3 SYSTEM OPERATION

ChlorKing® systems operate when both the main power supply and blue control cord have power applied to them. The ChlorKing® system will continue to operate for as long as power is applied from those two sources.

The system has an output range of 5-100% of the rated chlorine production for the model installed and can be adjusted by turning the black knob on the side of power supply box in a clockwise or anti-clockwise direction.

3.4 DISPLAY INFORMATION

During normal operation the display will have the following information available:

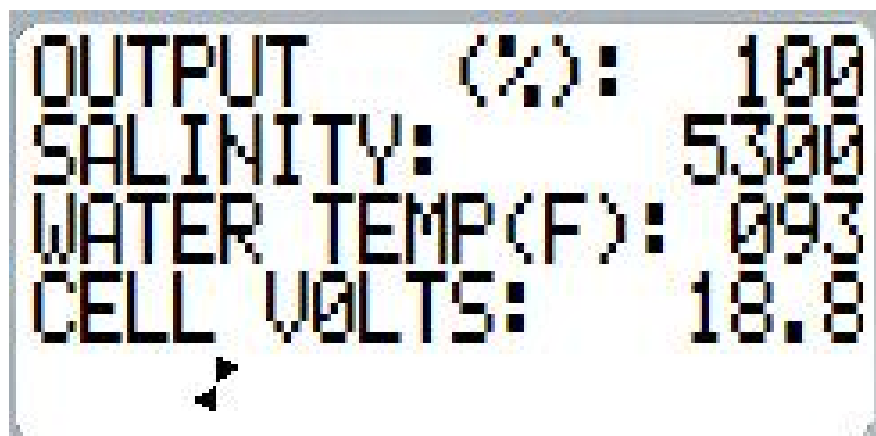

This screen is displayed when the system is waiting for a signal on the blue cord from an external source such as a chemical feed controller. The system will not generate chlorine until this signal is received.



The screen below is displayed when the system detects no flow through the electrolytic cell housing. This condition will stop the system from generating chlorine. Once flow is restored, the system will start automatically and this screen will no longer be active.

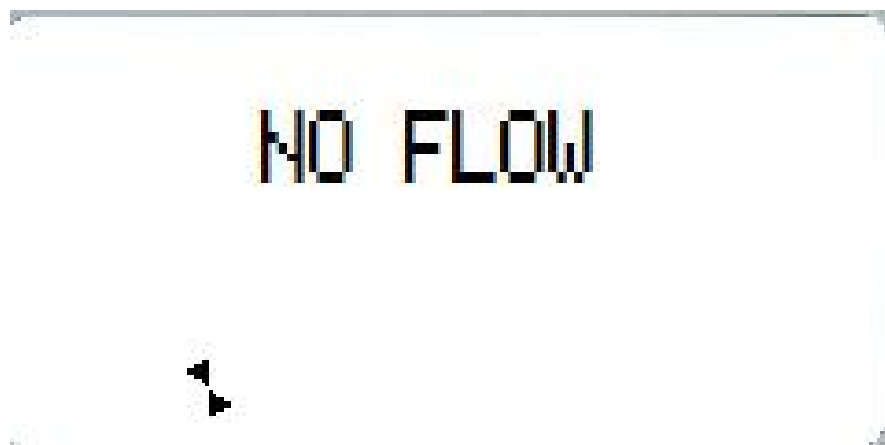

This screen is displayed if a low salt condition is present. Any salt concentration below 3000 ppm will stop the system output and display this screen. When the salt concentration is raised above 3000 ppm, normal system operation will resume.



This screen will be displayed if water temperature drops below 59° F. The system will continue to generate chlorine. Prolonged operation at high system outputs and temperatures below 59° F is not recommended. Adjusting the system output to 50% or less will eliminate this screen.



The screen below indicates a disconnected or defective salt sensor. This screen will shut the system output off. Reconnect or replace the salt sensor to restore system operation.

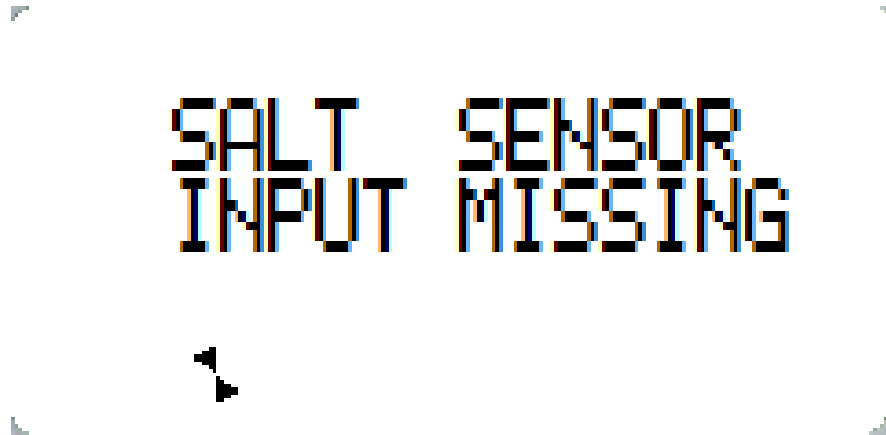

In order to prevent the system from being cycled on and off rapidly, the system has start delay of 60 seconds. During this delay the screen below is displayed.



The following screens are available by accessing the micro controller inside of the power supply.

WARNING

THE POWER SUPPLY CONTAINS HIGH VOLTAGE CIRCUITS THAT CAN CAUSE INJURY OR DEATH. ONLY PERSONS CERTIFIED AND TRAINED TO SERVICE THESE UNITS SHOULD ACCESS THE FOLLOWING SCREENS. WHEN MAINTAINING THIS EQUIPMENT, KEEP SAFETY CONSIDERATIONS FOREMOST. USE PROPER TOOLS, PROTECTIVE CLOTHING, AND EYE PROTECTION WHEN WORKING ON THE EQUIPMENT. FOLLOW THE INSTRUCTIONS IN THIS MANUAL AND TAKE ANY ADDITIONAL SAFETY MEASURES APPROPRIATE. THE PERSONNEL RESPONSIBLE FOR MAINTENANCE OF THIS EQUIPMENT MUST BE FULLY FAMILIAR WITH THE CONTENTS OF THIS MANUAL.

Daily system run time can be viewed by pressing and holding the “A” button on the microcontroller for 5 seconds.

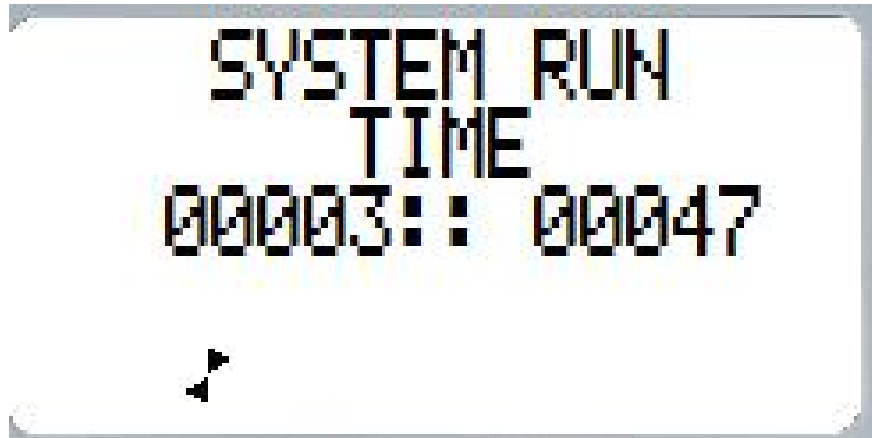

This system is capable of controlling the salt concentration of the pool with the addition of an external relay. The factory set point for salt is 5000 ppm. The salt set point can be adjusted to any value between 3000 and 7000 ppm. To access the salt set point screen, press and hold the “B” button on the microcontroller for 5 seconds and use the up down buttons to adjust the salt set point.



SECTION 4 MAINTENANCE

ChlorKing® systems are designed to operate 24 hours a day and 7 days a week at maximum production rates and will give you years of trouble free use if you follow these basic maintenance and cleaning instructions.

This system produces sodium hypochlorite “liquid chlorine” from the salt that you have added to the water. It will only continue to operate correctly if salt is maintained at a minimum 3500 ppm level. Low salt will lower the amount of chlorine produced, and cause damage to the electrolytic cell. When maintained properly the electrolytic cell has a life of 15,000 hours. **(Warranty’s will not be honored if it is determined that salt has been run low.)**

The titanium plates that make up the cell will last 15,000 hours or more if properly maintained. By ensuring that salt is always at the correct level, and plates are cleaned regularly, you will ensure 15,000 hours of operation or more.

Check salt concentration. Salt must be maintained at 3500 to 5000 ppm. Check salt as often as necessary to ensure the concentration.

Adjust the salt concentration as often as needed to maintain the desired level.

Test the flow switch for proper operation at least once a month and clean the strainer as often as needed.

To test the flow switch, close the lower cell isolation valve stopping flow to the cell. Immediately check to see if the system shut off. If the system does not shut off, immediately open the valve. **Do not allow the system to operate with the valve closed.** Replace a defective flow switch immediately.

To clean the strainer, disconnect power from the system, close the lower cell isolation valve and then close the upper cell isolation valve. Unscrew the strainer cover. Allow pressure to release slowly. Remove the strainer screen, clean the screen and reinstall.

Evaluate the cell condition every week

Visually inspect the cell tube for leaks and the cell stack for calcium build up. Check the connections at the top of cell and clean as needed.



This electrode stack is in excellent condition and does not require cleaning



A cell stack with calcium bridged plates.

Clean the cell when calcium buildup is present (reverse polarity systems)

WARNING

Read all cautions and directions provided with the muriatic acid used. Always add acid to water. Use only with adequate ventilation. If strong odor is noticed, STOP, ventilation is inadequate. Leave area immediately. If the work area is not well ventilated you MUST use a properly fitted and maintained NIOSH approved respirator for acid fumes.

To clean the cell manually, disconnect power from the system, close the lower cell isolation valve and then close the upper cell isolation valve. Disconnect the cables from electrolytic cell. Remove the bolts holding the electrolytic cell stack in the cell tube and lift the cell out of the cell tube. Immerse the cell in a solution with a 4 to 1 water and muriatic acid mixture. Leave the cell in the muriatic acid solution until the cell is clean. Do not leave the cell in the muriatic acid solution any longer than necessary to clean the cell. Reassemble the cell stack in the tube and reconnect the cables to the top of the cell stack.



Clean the cell when calcium buildup is present with the ChlorKing® Acid Wash System (non-reverse polarity system)

WARNING

Read all cautions and directions provided with the muriatic acid used. Always add acid to water. Use only with adequate ventilation. If strong odor is noticed, STOP, ventilation is inadequate. Leave area immediately. If the work area is not well ventilated you MUST use a properly fitted and maintained NIOSH approved respirator for acid fumes.

4.1 Acid Wash Operation

Turn off the power to the chlorinator to be serviced.

Close the lower and upper cell tube ball valves [1] and [2]. Always close the lower ball valve [1] first to avoid damaging the cell tube.

Open the lower and upper acid wash ball valves [3] and [4]. Drain the water from the cell tube.

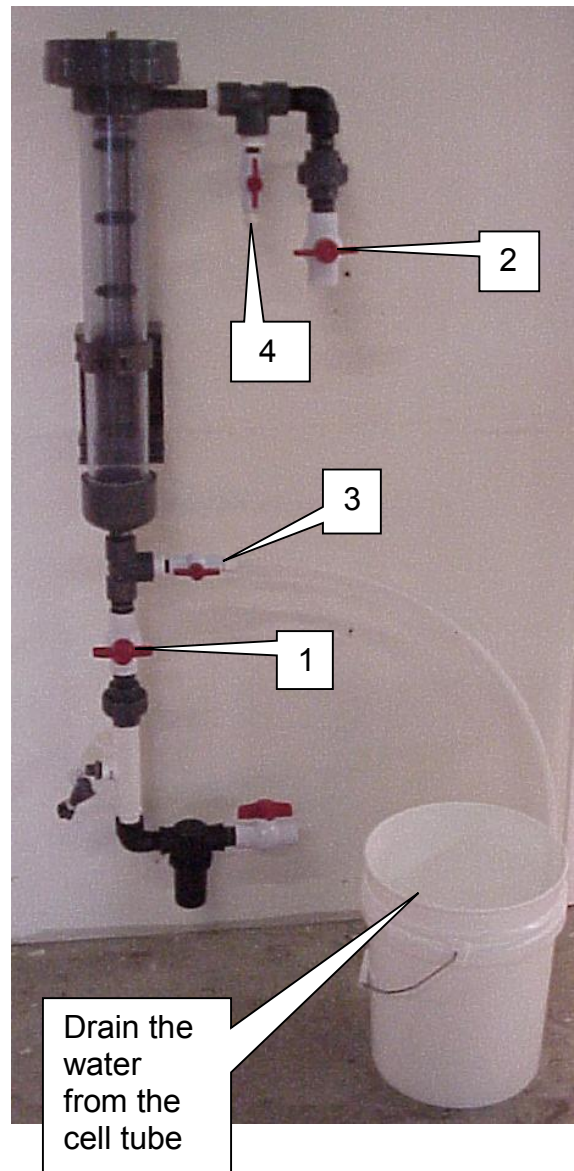

Connect the acid wash tank and pump to the acid wash valves [3] and [4] as shown in the photo on the right.

Fill the acid wash tank with 4 gallons of water and 1 gallon of muriatic acid.

Open the white wash valves [5] and [6]. Open the tank feed valve [7].

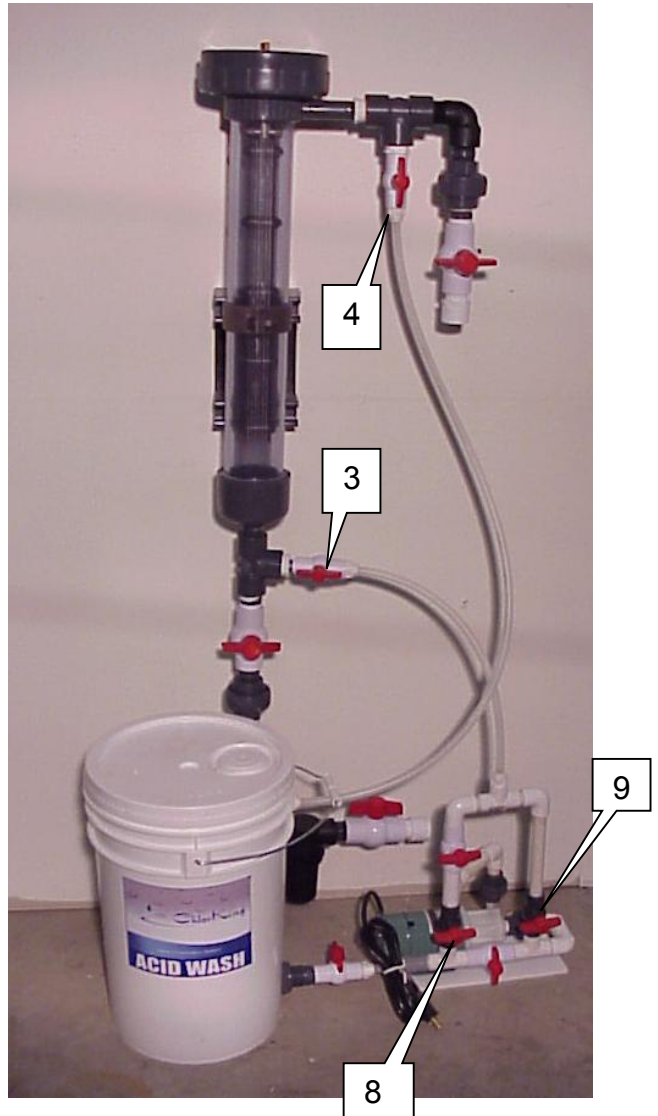
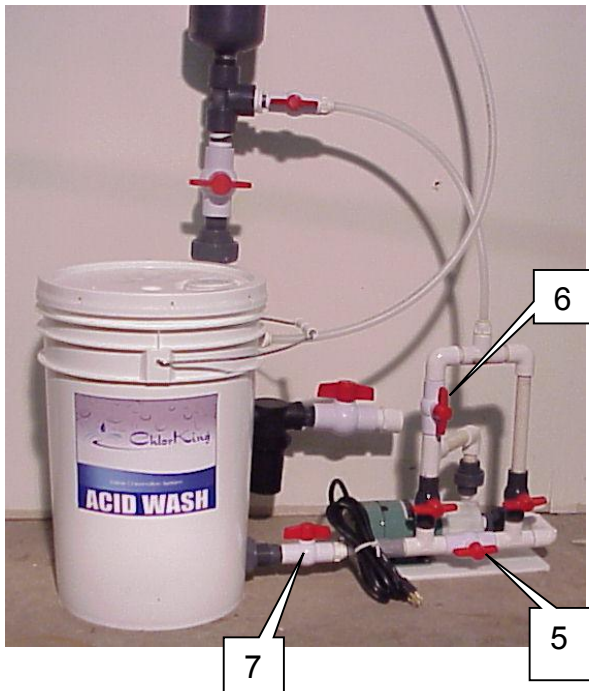

Plug the Acid Wash pump in to a 120 VAC source and start the wash cycle. Allow the pump to run until the cell is clean.

When the cell is clean, leave the Acid Wash pump running and open the grey drain valves [8] and [9] and close the white wash valves [5] and [6]. The cell tube will now drain into the wash tank. When the cell is empty, unplug the pump immediately. Do not let the pump run dry.

Close all acid wash valves [3], [4], [5], [6], [7], [8] and [9]. Open the 2 cell tube valves [1] and [2]. Restart the system.

NOTE: All acid wash valves must be closed prior to restarting the system or damage to the acid wash tank may occur.

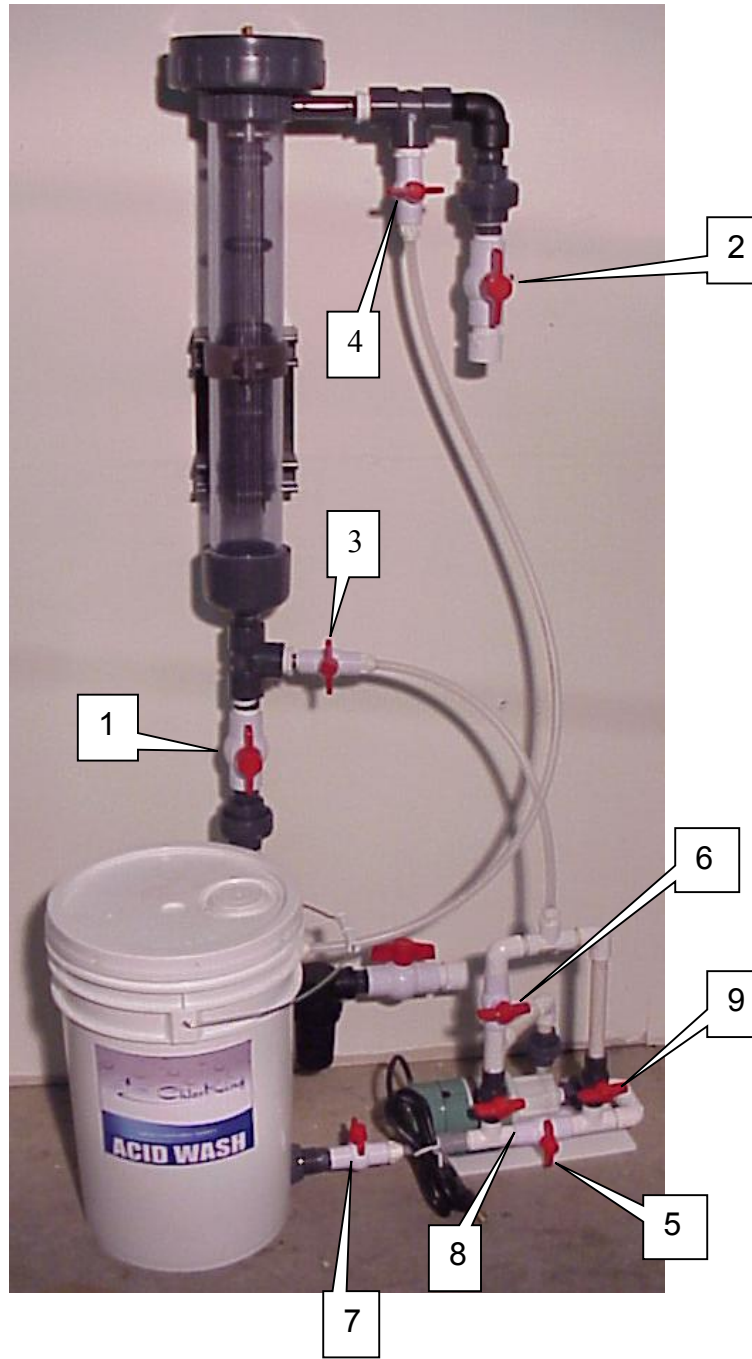

Visually inspect the power supply once every month.

Open the enclosure and visually check for any abnormal conditions such as burned wires, loose connections or corrosion.

Operate the system to verify performance once every month.

Turn the system on.

Adjust the control knob to the full off position and note that the amps displayed on the meter go to zero.

Adjust the control knob to the maximum position and verify that amps go to maximum.

Adjust the control knob to the desired setting.

SECTION 5 WARRANTY INFORMATION

The ChlorKing® system carries a limited 3-year warranty
3-year warranty on assembly of electrical components and production tank.
1 year on all electrical items.
2 years or 15,000 hours, whichever occurs first, pro-rated hourly, on titanium electrodes. (Year 1 is warranted fully, thereafter pro-rated warranty applies, applicable over the full 2-year period. Applicable on electrode stacks where full price has been paid.)

ChlorKing® advises that titanium electrodes will have to be replaced every 15,000 hours of operating time. Under no circumstances shall the replacement titanium electrodes exceed the original 15,000-hour warranty.

ChlorKing® warranties will not be honored should it be shown that the operating and maintenance procedures have not been followed, particularly with regard to the cleaning frequency program.

ChlorKing® warranties of the titanium electrodes will not be honored if the system is operated in water temperatures lower than 59 degrees F.

During the warranty period the customer shall return the defective component, freight prepaid, accompanied by the original invoice or proof of purchase, and ChlorKing® shall at its sole discretion elect to repair or replace the defective component and return it to the customer, freight pre-paid.

ChlorKing® accepts no responsibility other than to repair or replace a defective component, and this warranty specifically excludes product failure due to accidental damage, abuse, misuse, and negligence, damage due to non-compliance of the operating manual or unauthorized alterations or modifications to the system. ChlorKing® accepts no responsibility and is not liable for any extended warranties or variations to this warranty offered by re-sellers of ChlorKing® systems.

Warranty Registration Card

Please complete and return to activate ChlorKing® warranty

Please mail or fax to ChlorKing® inc. P.O. Box 80823, Atlanta, GA, 30366 Fax: 770-685-6576

Dealer Name: _____

Address: _____ City: _____

State: _____ Zip: _____ Tel: _____

Installation site of equipment: _____

Address: _____ City: _____

State: _____ Zip: _____

Date of purchase: _____ Serial number: _____

1. Pool size: _____ 2. Pool finish: _____

3. Indoor / Outdoor: _____ 4. Heated: Yes / no

5. Filter Type: _____ 6. Pool Age: _____

7. New or existing pool: _____ 7. Controller installed: Yes / No

8. If controller installed, what make and model: _____